

EasyFresh® NEXT

Operator's manual



XS | S | M | L SL | ML | LL

MONOCOQUE



TRANSLATION OF THE ORIGINAL INSTRUCTIONS

IRINOX
The Freshness Company®



Dear Customer, thank you for choosing IRINOX.

this manual contains all the information necessary for the correct use and maintenance of the equipment.

We therefore recommend that you read it carefully before assembly and keep it safe for future reference.

If any steps are not well understood, Irinox remains available to provide any further information.



USE AND MAINTENANCE

Safety for use and cleaning	p. 4
Basic principles	p. 12
Use	p. 16
Maintenance	p. 26

Service Department | +39.0438.2020
Fax | +39.0438.2023
E-mail | service@irinox.com
Web site | www.irinoxprofessional.com

For any information always indicate:

- the blast chiller model
- the serial number can be found on the serial number plate applied on the lower right side, near the front grille

Safety for use and cleaning

Explanation of the meaning of the pictograms

To make the reading clearer and more pleasant, symbols have been used in this manual to convey to the reader the meaning or importance of the information provided by the phrases next to them.



Indicates that caution is required when performing an operation described in a paragraph bearing this symbol. The symbol also indicates that maximum operator awareness is required in order to avoid unwanted or dangerous consequences



Indicates important information to read and comply with.



Indicates requirements relating to actions that must be avoided.



This symbol located on the machine or referred to in the manual identifies the areas that reach high temperatures that might constitute a burn hazard.



This symbol placed on the machine or referred to in the manual identifies areas with electrical hazards.



Indicates grounding.



Identifies the terminals which, connected together, bring the various parts of an appliance or system to the same potential (not necessarily the earth potential).



Indicates that it is necessary to carefully read the paragraph marked with this symbol before installing, using and maintaining the equipment.



Indicates useful tips and information.



Indicates a reference to another chapter where the topic is addressed in more detail.

Who should read this manual

These instructions are mainly addressed to the operator, who must read them carefully before using and maintaining the equipment.

 The user must not carry out operations other than those provided for in these instructions.

From this moment on, the term "APPLIANCE" means the Easyfresh Next blast chiller.



General warnings

Failure to comply with the following provisions can cause damage, breakdowns and even fatal injuries, voids the warranty and releases Irinox from all liability. If they are not understood, contact Irinox before using the appliance.

 **CAUTION:** Read the instructions before using the machine. If you have not understood all the contents of the manual, contact Irinox before using the appliance. This manual is an integral part of the equipment and must accompany it throughout its useful life. Keep the manual with care, in a dry and accessible place near the location of the equipment, for any further future consultation by the various operators when they deem it necessary.

 The use is reserved only for suitable and trained personnel, subjected to periodic training courses. Untrained personnel must never operate this equipment since, in that case, its use entails a high probability of serious accidents.

Given the continuous progress in the design sector, the manufacturer reserves the right to make changes to the production and instructions, without this implying the obligation to update the production and previous instructions. If necessary, further copies or updates of these instructions must be requested from the manufacturer of the equipment.

 The status of the machine stopped, detected by means of a visual inspection of the same, does not guarantee with certainty that the equipment is turned off. In order to guarantee his safety, the operator must verify that the machine is not live, that is, that its plug is disconnected or the switch on the panel to which it is connected is in the "OFF" position.

 Before using the equipment, it is necessary to acquire adequate knowledge of the same. For this reason it is necessary to inspect it carefully, to ensure that all the indications contained in this manual match the configuration of the blast chiller exactly. Do not use the equipment before having carried out an adequate fact-finding inspection.

 Any use and cleaning other than those indicated and provided for in this manual are considered improper and can cause damage, injury or fatal accidents, void the warranty and release Irinox from all liability.

 Do not operate the equipment without being equipped with the personal protective equipment prescribed in this manual (see chapter "**Personal protective equipment (PPE): what they are and why they should be used**" on page 8).

 Do not approach the electrical parts with wet or bare hands.

 It is absolutely forbidden to tamper with or remove the adopted safety devices (safety grilles, danger stickers, etc.). Irinox declines all responsibility if the above instructions are not complied with.

 Do not insert any object between the protections (fan protectors, evaporators, etc.).

 For the compressor and evaporator unit to work properly, never obstruct their air intakes.

 In the event of a fire, do not use water, take a CO2 (carbon dioxide) extinguisher and cool the area of the engine compartment as quickly as possible.

 Before use, make sure that there are no non-compliant objects (e.g. instruction manuals or anything else) or detergent residues inside the cell of the equipment.

 This equipment is considered an agri-food machine (EC Regulation No. 1935/2004), intended for cooling or cooking (if any) food products, any other use is considered improper. Irinox is not responsible and recognizes no warranty rights in case of improper use.

 At the end of the cooling cycle, remove the food from the appliance and store it properly.

 This equipment is not suitable for the storage of pharmaceutical, chemical or any other non-food products.

The equipment has been built and designed with the appropriate precautions in order to ensure the health and safety of the user and does not have dangerous edges, sharp surfaces or elements protruding from the dimensions.

 If the equipment does not work or you notice functional or structural alterations, disconnect it from the mains and contact a service centre authorized by Irinox without

attempting to repair it yourself. The use of original spare parts is mandatory. Irinox accepts no responsibility for the use of non-original spare parts.

 If the equipment is fitted with wheels, be careful not to push the equipment violently while moving it, to prevent it from tipping over, being damaged and damage anything else, also pay attention to any roughness in the sliding surface.

 The equipment fitted with wheels cannot be levelled, so make sure that the support surface is perfectly horizontal and flat.

During normal use, always lock the wheels with the special brakes.

 Do not store explosive substances such as spray cans with flammable propellant in this appliance.

 This appliance is not intended for use by persons with reduced physical, sensory or mental abilities, or lack of experience and knowledge, unless they have received supervision or instructions regarding the use of the appliance from a person responsible for their safety.

 The appliance is not to be used by children, and they must be given supervision so that they do not play or approach the appliance.

 Cleaning and user maintenance shall not be made by children.

The appliance has a sound emission of less than 70 dB.

 In compliance with the MOCA / FCM regulation (CE 1935/2004, CE 2023/2006, DM 21/03/1973), the use of a lid is required for the first tray inserted in the upper part of the blast chiller.

Specific warnings for maintenance and disposal

 Extraordinary maintenance operations (e.g. replacement of faulty components) are reserved for specialized maintenance personnel.

The operator must limit himself to the normal routine cleaning of the surfaces, complying with the following warnings and the methods indicated in the specific chapter.

 When maintenance and cleaning operations are carried out, the blast chiller must be turned off and disconnected from the power supply, and the operator must be at all times in a position to verify that no connection is restored.

 A sign must be placed near the cable with the blast chiller power supply, indicating that disconnection has taken place as a maintenance or cleaning operation is in progress, and the power supply must not be restored.

 The operator in charge of cleaning must be provided with adequate personal protective equipment (see chapter **“Personal protective equipment (PPE): what they are and why they should be used”** on page 8).

 It is absolutely forbidden to use solvents or, in general, flammable substances for cleaning the parts of the blast chiller.

 The substances used for cleaning and disinfecting the surfaces of the blast chiller must be compatible with the materials of the blast chiller and with hygiene requirements. We recommend using mild soap or detergents.

 Do not remove the blast chiller protections to perform maintenance and cleaning operations.

Make sure you have completely dried the blast chiller before use.

 When disposing of the blast chiller, it is necessary to destroy its identification plate, as well as the documentation provided for purchase.

 Do not place sources of heat (e.g. grills, fryers, etc.), easily flammable or combustible substances near the appliance (e.g. diesel, petrol, bottles of spirits, etc.).

 For safety reasons, DO NOT place the last tray at a height greater than 1750mm because, while inserting it, the boiling cooking

liquids could leak and seriously burn the operator.



The yellow “burn hazards” sticker reminds you of this safety precaution.

Residual risks

The risks present in all operational and life stages of the blast chiller are listed and organized below by type of operation/condition, with a brief description of the measures taken to eliminate, as far as possible, the risks for operators and/or to limit or reduce the risks deriving from the dangers which cannot be totally eliminated at source.

List of risks:

- mechanical risks;
- temperature risks;
- transport risks.

Mechanical risks

Risk from danger of: crushing or impact with the blast chiller door.

Warning: if the equipment is not correctly levelled, the blast chiller door can move uncontrollably;

Prevention: ensure the stability of the blast chiller door by making sure that when it opens it remains in position or at most tends to close slowly.

Risk of entanglement

Prevention: use tightly fitting clothing with no flying flaps.

Risk of perforation / puncture.

Prevention: handle the core probe with care and with protective gloves.

Risks due to handling

Risk due to: loss of stability of the blast chiller on wheels during handling.

Warning: check the stability of the blast chiller before moving it on its wheels; check the characteristics of the surface on which the blast chiller is moved.

Prevention: check the correct conditions of the floor before moving the equipment; do not pull the blast chiller, just push it

Risks due to slipping

Risk due to: slipping

Warning: check that the floor near the equipment is dry and not slippery;

Prevention: periodically check the level of the liquids contained in the water collection lower tray to avoid overflowing.

Limits and requirements

Operators suitable to use the equipment

● The use of the equipment must be allowed only to professional operators. All operators must have been specifically trained in performing the tasks, and practically trained to carry them out.

⊘ "Qualified personnel" cannot operate on the blast chiller if they take substances that increase reaction times.

In the event that the owner of the blast chiller is unable to provide sufficient training to staff, it will be his responsibility to ask Irinox or the seller to train his staff adequately.

⊘ Personnel must not try to "self-train", based on documentation or experiences that are not conducted directly on a blast chiller identical to that covered by this manual, in the specific tasks they intend to cover.

● Knowledge of the requirements contained in these instructions is mandatory, but does not replace the operator's required experience.

Personal protective equipment (PPE): what they are and why they should be used

In order to prevent the risks that can be generated by the installation of the equipment, all operators who come into contact with it must be equipped with adequate personal protective equipment (PPE), such as:

- **clothing adhering to the body** and without flying flaps that can get caught (if not already provided for by the legislation relating to the environments in which the equipment will be used);
- **gloves** against the danger of burns;

- **safety shoes** (unless already provided for by the legislation relating to the environments in which the blast chiller will be used);
- **safety goggles.**

Personnel in charge of operation

● The equipment must be operated by only one operator at a time. The operator must never intervene in order to carry out interventions on the blast chiller other than the management as described below; all maintenance, repairs or other operations other than management are to be considered as reserved for the personnel in charge.

● When abnormal operating conditions or malfunctions occur in the blast chiller, only service can restore normal operation.

⊘ Never intervene in order to solve machine downtime situations that are not strictly related to the management task. Never try to help maintenance personnel.

Environmental requirements

● This blast chiller must operate in an environment that meets the following requirements.

If it is used outside the listed limits, mechanical failures or malfunctions may occur.

⊘ The equipment is not expected to be used in an explosive atmosphere; therefore the user is prohibited from using the equipment in an explosive or partially explosive atmosphere. The equipment must not be exposed to vibrations, high frequency noise, dust or foreign materials, because such exposure can cause deterioration or mechanical breakdowns. Furthermore, it must not be exposed to atmospheric agents (rain, hail, fog, snow, etc.). The distances shown in the following figures must also be maintained.

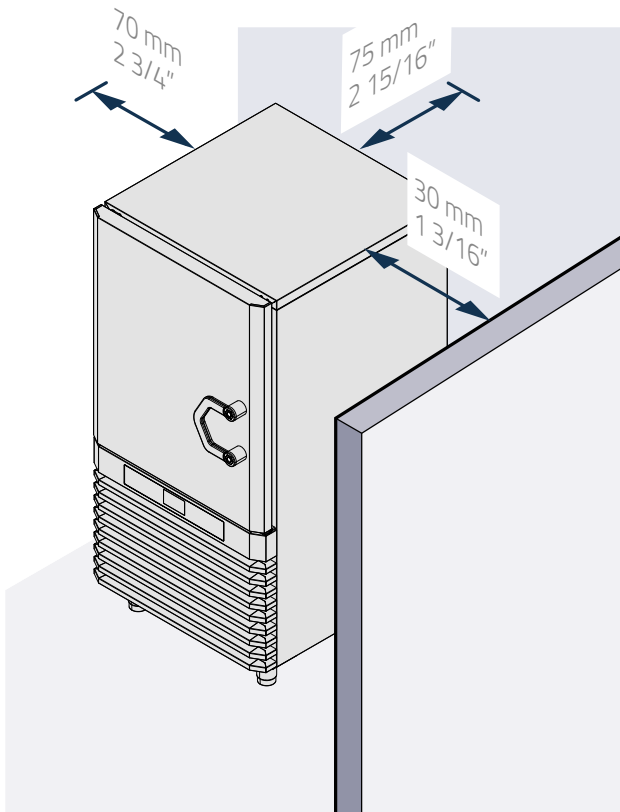

Models M | L | ML | LL

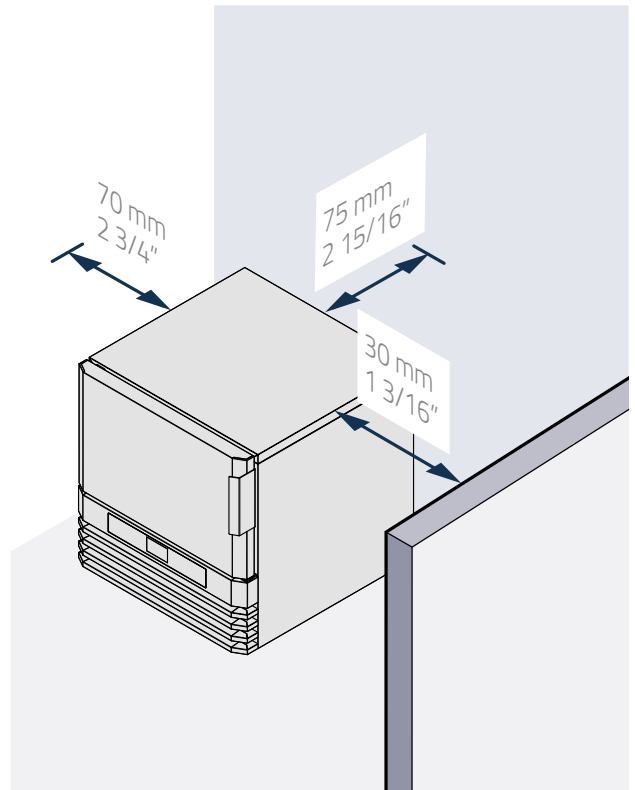

Models XS | S | SL

F01

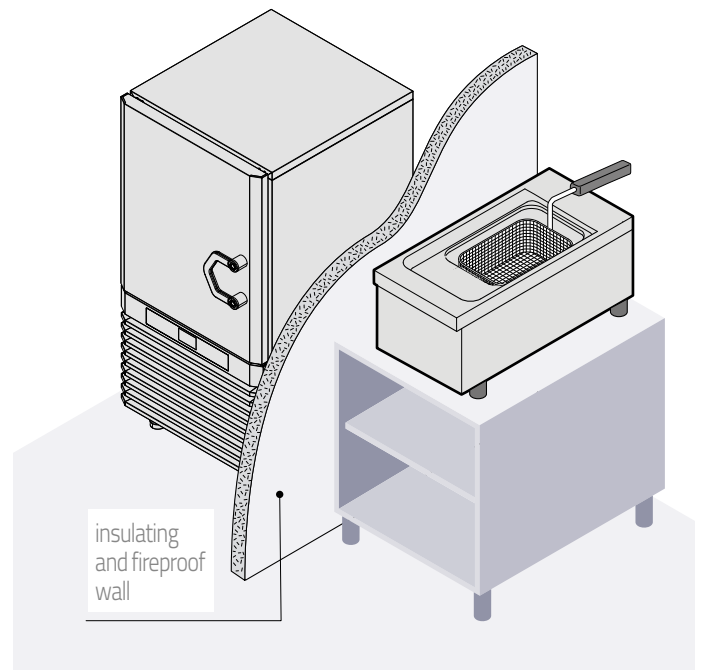
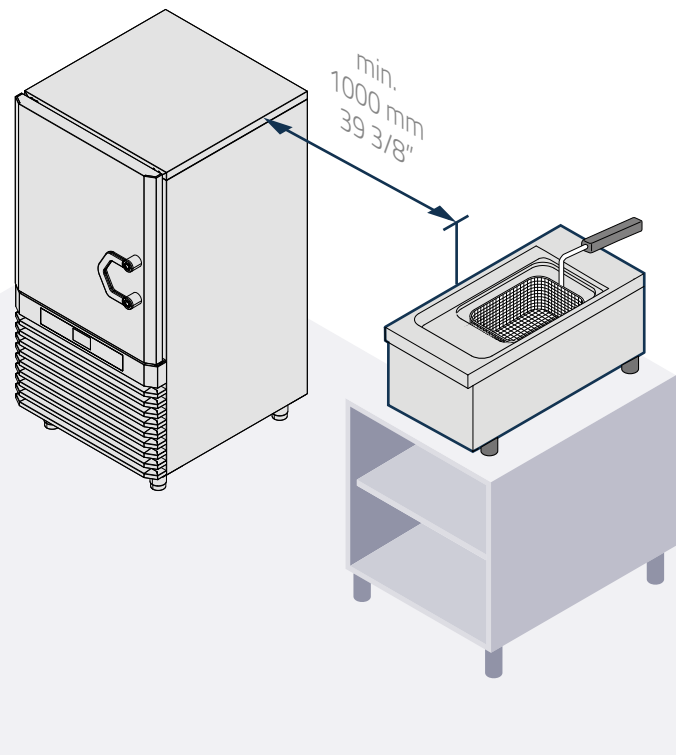

F02

Refrigerant gas warnings

The equipment works with R452A refrigerant gas (R404a on request).

High inhalation exposures can cause anaesthetic effects. Very high exposures can cause abnormal heart rhythms and sudden death. The sprayed or splashed product can cause frost burns to the eyes or skin. Dangerous for the ozone layer.

First aid measures

Inhalation

Remove the injured person from exposure, and keep him warm and at rest. If necessary, administer oxygen. Practice artificial respiration if breathing has stopped or shows signs of stopping. In case of cardiac arrest, perform external cardiac massage. Get immediate medical attention.

Skin contact

Thaw the affected areas with water. Remove contaminated clothing. Warning: clothing can stick to the skin in the event of frost burns. In case of contact with the skin, wash immediately with plenty of lukewarm water. If symptoms occur (irritation or blistering) seek medical attention.

Eye contact

Wash immediately with an eye wash solution or clean water, holding the eyelids apart, for at least 10 minutes. Get medical attention.

Ingestion

Do not induce vomiting. If the injured person is conscious, rinse his/her mouth with water and get him/her to drink 200-300 ml of water. Get immediate medical attention.

Further medical treatment

Symptomatic treatment and supportive therapy when indicated. Do not administer adrenaline and similar sympathomimetic drugs following exposure, due to the risk of cardiac arrhythmia with possible cardiac arrest.

Firefighting measures

Non flammable.

Thermal decomposition causes the emission of very toxic and corrosive vapours (hydrogen chloride, hydrogen fluoride). In case of fire, use self-contained breathing equipment and suitable protective clothing.

Extinguishing agents

Use extinguishing agents appropriate for the adjacent fire.

Toxicological information

Inhalation

Higher atmospheric concentrations can cause anaesthetic effects with possible loss of consciousness. Very high exposures can cause abnormal heart rhythms and sudden death. Higher concentrations can cause asphyxiation due to the reduced oxygen content in the atmosphere.

Skin contact

Splashed and sprayed liquid can cause frost burns. It is unlikely to be dangerous by skin absorption. Repeated or prolonged contact can cause the removal of skin fat, resulting in dryness, cracking and dermatitis.

Ecological information

It decomposes relatively quickly in the lower atmosphere (troposphere). Decomposition products are highly dispersed and therefore have a very low concentration.

It does not affect photochemical smog (i.e. it does not fall within the volatile organic compounds - VOC - according to the provisions of the UNECE agreement).

The ozone depletion potential (ODP) is 0 for both R404A and R452A measured against a standard ODP equal to 1 for cfc11 (according to the uNeP definitions). The global warming potential of gas (GWP) is 3260 for R404A and 2141 for R452A.

The substance is regulated by the Montreal Protocol (1992 revision). Product discharges released into the atmosphere do not cause long-term water contamination.

Disposal considerations

The best solution is to recover and recycle the product.

If this is not possible, destruction must take place in an authorized plant equipped to absorb and neutralize acid gases and other toxic processing products.

Accidental release measures

Ensure adequate personal protection (with the use of means of protection for the respiratory tract) during the elimination of spills.

If conditions are sufficiently safe, isolate the source of the leak. In the presence of small spills, allow the material to evaporate on condition that there is adequate ventilation.

Significant losses:

- ventilate the area;
- contain the spilled material with sand, soil or other suitable absorbent material;
- prevent liquid from entering drains, sewers, basements and work pits, because the vapours can create a suffocating atmosphere.

Handling

Avoid inhalation of high concentrations of vapours. Atmospheric concentrations must be kept to a minimum and kept to the minimum reasonably possible level, below the occupational exposure limit.

The vapours are heavier than air, and therefore it is possible to form high concentrations near the ground where general ventilation is poor.

In these cases, ensure adequate ventilation or wear suitable respiratory protective devices with an air reserve. Avoid contact with open flames and hot surfaces as irritating and toxic decomposition products can form.

Prevent the liquid from coming into contact with the eyes/skin.

Basic principles

What is a blast chiller and what is it for

Before using the equipment it is necessary to know it thoroughly. For this reason, the following explains in detail what a blast chiller is and its possible uses.

A blast chiller **quickly lowers the temperature of food**, whether fresh or already cooked: freshly cooked food has the highest organoleptic qualities and flavour.

Already after a few hours, however, if not consumed, it loses its initial quality characteristics and there is a proliferation of microorganisms potentially dangerous for humans.

Unlike a blast chiller, ordinary refrigerators and freezers do not have the ability to quickly lower the initial temperature of the product, consequently the latter is damaged organoleptically and in flavour.

Two types of cooling are possible: **positive** or **negative**.

Cooling reduces the product temperature within 90 minutes until it reaches **+3°C | 37°F** at the core.

The product must subsequently be stored at a temperature of **0/+3°C | 32/37°F** where it can be kept up to 5 days.

Freezing reduces the product temperature within 240 minutes until it reaches **-18°C | 0°F** at the core.

The product must then be stored at a constant temperature of **-18/-20°C | 0/-4°F** and can be consumed also after 3/18 months (depending on the type of product) as long as the cold chain is complied with.

F04 **Avoid keeping cooked food to be cooled or frozen quickly at room temperature for long periods of time.**

It is advisable to start the cooling or freezing cycle as soon as the preparation is finished. Cooked food can enter the blast chiller even at very high temperatures (>100°C | 212°F), as long as the chamber is pre-cooled.

To have the best final quality of the product at all times, we recommend you pre-cool the cell before inserting a product, especially if it is very hot. Weight loss phenomenon due to food water evaporation is reduced, as well as the cooling times.

At the end of a cooling cycle, both positive and negative, the **maintenance phase** of the blast chilled products begins, to keep them at temperature until their removal which must take place in the shortest possible time.

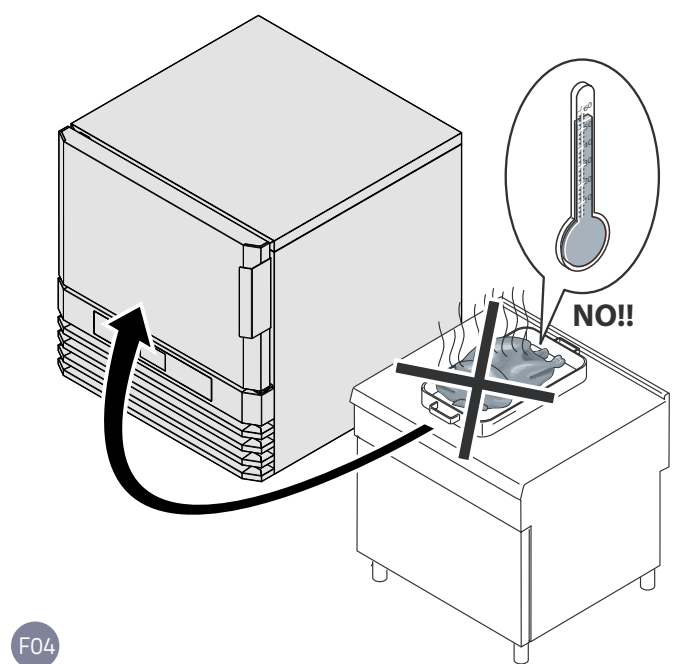
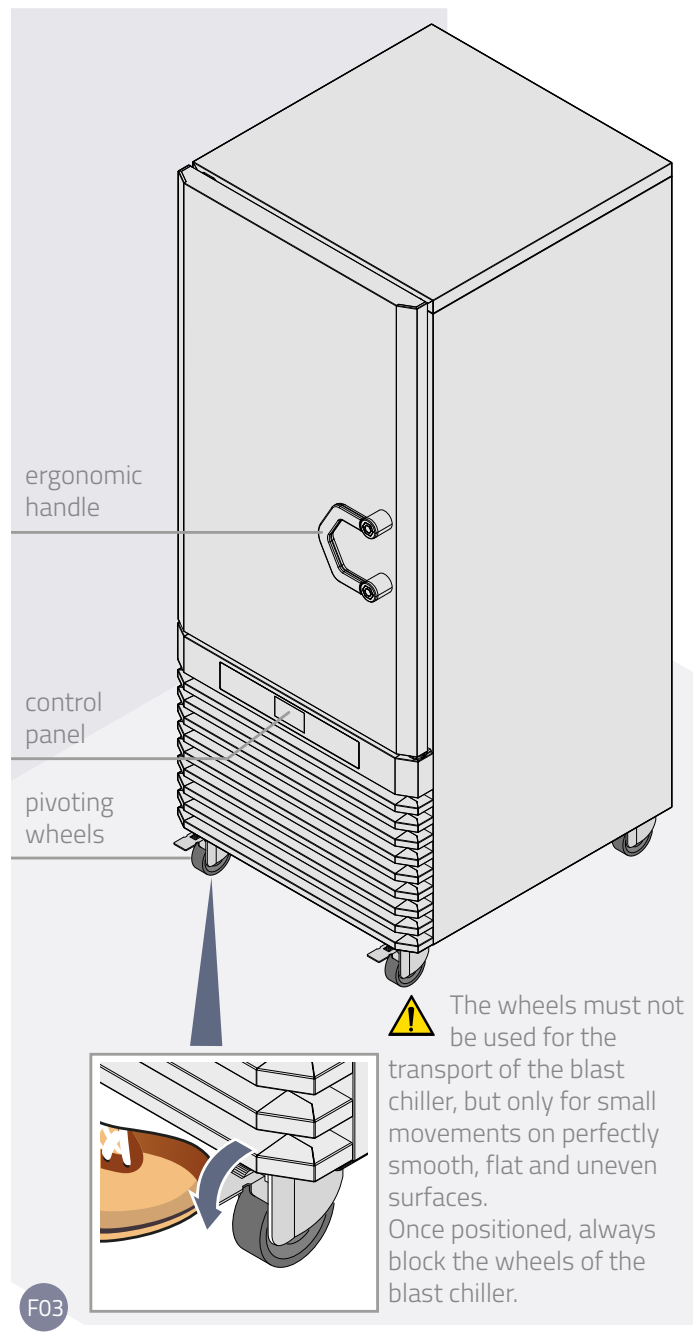

Do not use the blast chiller to keep the products already chilled but remove and store them:

- in the refrigerator at a temperature of 0/+3 °C | 32/37 °F where they can be kept for up to 5 days;
- in a storage unit at a constant temperature of -18/-20 °C | 0/-4 °F (Freezing). They can be consumed also after 3/18 months (depending on the type of product) as long as the cold chain is complied with.

Chilled and/or frozen food must be specially covered and protected (with film, with an airtight or better still vacuum-sealed lid) and marked with an adhesive label on which the contents, day of preparation and assigned expiration date are stated in indelible ink.

The equipment has the ability to operate in the following modes:

- **MANUAL:** the operator must manually enter the **duration of the cooling cycle** which will end when the set time is reached.
- **AUTOMATIC:** the operator must stick the core probe into the food to be blast chilled. In this way it will constantly detect the core temperature of the food in the cell. The cooling cycle ends when the probe detects that the temperature set for the selected cycle has been reached (e.g. 3 °C | 37 °F).

At the end of the daily use of the appliance, perform a defrost cycle:

Defrosting the machine is essential to remove ice from the evaporator and to dry the cabinet, in order to have the machine ready for the next working shift and to avoid bacterial proliferation.

When the blast chiller is not used, leave the door ajar, in order to allow natural air circulation, or alternatively keep the door closed if Sanigen® is present.

How to use the core probe

F05 The core probe must be positioned correctly in the centre of the product of larger size or cut, taking care that the tip of the probe does not come out of the product itself or that it does not touch the tray. In order to avoid unwanted contamination, the probe must be cleaned and sanitized before each work cycle.

The phases managed with the core probe **end when it detects that the “core” of the food has reached the temperature set for the cycle**: unlike the phases set with a duration, the detection of the temperature ensures that the processed food has been cooled, frozen or cooked properly. The machine can detect the presence of the probe automatically.

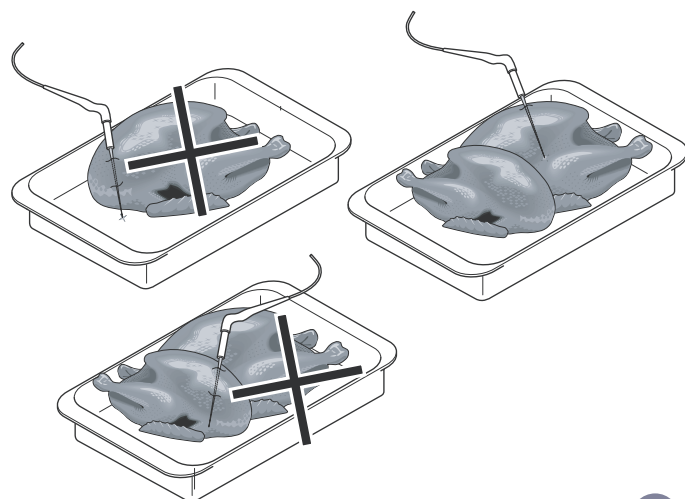

F05

Cycle descriptions

DELICATE Cycle +3°C | 37°F

With this cycle, the temperature of the food is reduced rapidly to +3°C | 37°F at the core, with a working temperature that varies between 0°C | 32°F and 2°C | 36°F. This cycle is particularly suitable for delicate products such as:

- Mousses,
- Spoon desserts,
- Creams,
- Desserts,
- Vegetables,
- Foods of reduced thickness

STRONG Cycle +3°C | 37°F

With this cycle, the temperature of the food is reduced rapidly to +3°C | 37°F at the core, with a working temperature that varies between -15°C | 5°F and 2°C | 36°F.

This cycle allows to significantly reduce working times and is particularly suitable for products:

- High in fat,
- Very dense,
- In large pieces,
- Packaged

DELICATE Cycle -18°C | 0°F

This cycle has two freezing phases.

In the first phase, the core temperature of the product is brought to +6°C | 43°F, with a working temperature of 0°C | 32°F. In the second phase, the core temperature of the product is brought to -18°C | 0°F, with a working temperature that can reach -35°C | -31°F.

This cycle is particularly suitable for freezing baked products.

STRONG Cycle -18°C | 0°F

With this cycle, the temperature of the food is reduced rapidly to -18°C | 0°F at the core, with a working temperature that can reach -35°C | -31°F.

This cycle is particularly suitable for freezing food quickly.

How to properly load the equipment

For best results we recommend loading GN1/1 trays with a maximum thickness of 5cm | 2" for both cooling and freezing. The dishes must be placed in containers:

- suitable for food use;
- resistant to the temperatures reached by the cooling and low temperature cooking cycles (if any);
- uncovered or with low edges (maximum 6.5 cm | 2 9/16"); the greater the surface of the food exposed to contact with cold air, the shorter the cooling times.

For best results we recommend loading containers with a maximum of 3.5 kg | 7.7 lb of product and with a maximum thickness of 8 cm | 3 1/8" for rapid cooling, or 5 cm | 2" for quick freezing, for difficult and/or fatty products reduce the thickness further.

If the machine is not fully loaded, concentrate the trays in the central part of the blast chiller by placing an empty tray on top of the last tray.

Place the trays in the innermost part of the tray holder, making sure they are as close as possible to the evaporator. The containers must be placed homogeneously and evenly inside the cell to allow free circulation of air. Avoid obstructing the ventilation fans and overloading the appliance beyond the permitted limits (see tables below).

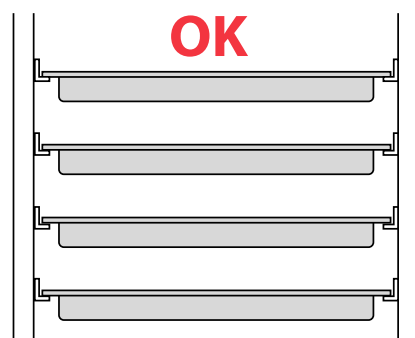
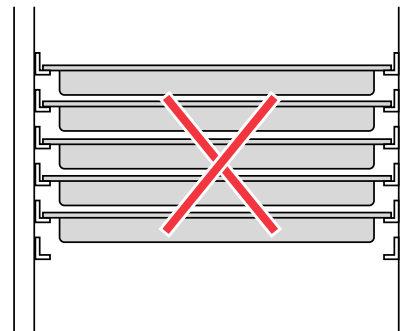

MAXIMUM LOAD PER TRAY

GN 1/1	30 kg (66,14 lbs)
GN 2/1	30 kg (66,14 lbs)

MOD.	CATERING						PÂTISSERIE		
	GN 1/1 h=20	GN 1/1 h=40	GN 1/1 h=65	GN 2/1 h=20	GN 2/1 h=40	GN 2/1 h=65	400x600 h=20	400x600 h=40	400x600 h=60
XS	3	3	3						
S	8	5	4				8	5	4
M	18	12	9				18	12	9
L	27	18	13				27	18	13
SL	14*	8*	6*	8	5	4	8	5	4
ML	34*	22*	16*	18	12	9	18	12	9
LL	54*	36*	26*	27	18	13	27	18	13

MOD.	ICE-CREAM								
	TUBS								CARAPINE CART
	330x165 x h120	330x165 x h150	330x250 x h120	330x250 x h150	360x165 x h120	360x165 x h150	360x250 x h120	360x 250 x h150	Ø 200 x h250
XS	1	1	1	1	1	1	1	1	
S	6**	6**	4**	4**	6**	6**	4**	4**	6**
M	15**	12**	10**	8**	15**	12**	10**	8**	12**
L	24**	18**	16**	12**	24**	18**	16**	12**	24**
SL	8***	8***	6***	6***	8***	8***	6***	6***	6***
ML	20***	16***	15***	12***	20***	16***	15***	12***	12***
LL	32***	24***	24***	18***	32***	24***	24***	18***	24***

(*) Tray to be placed on a 530x650mm grille or on a double support

(**) Tray / Carapina to be placed on a 400x600mm grille

(***) Tray / Carapina to be placed on a 530x650mm grille

USA - Canada

MOD.	GASTRONOMY	PASTRY		ICE CREAM
	304.8 x 508 x h63.5 mm	457.2 x 330.2	457.2 x 660.4	360 x 165 x h120 mm
	12" x 20" x 2 1/2"	18" x 13"	18" x 26"	14 11/64" x 6 1/2" x h 4 23/32" (5L)
XS	3	3	-	1
SL	6**	10**	5	8****
ML	18**	24**	12	20****
LL	26**	36**	18	32****

(*) Tray to rest on 12 51/64" x 20 55/64" grille

(**) Tray to rest on 26 5/8" x 18 1/4" grille

(***) Gelato Pans / Round Container to rest on 12 51/64" x 20 55/64" grille

(****) Gelato Pans / Round Container to rest on 26 5/8" x 18 1/4" grille

Use



Safety warnings

Read this manual carefully before operating the machine. If you have not understood all the contents of the manual, contact Irinox before using the appliance.

- From its default working position, the operator using the equipment can maintain full control of all the control devices of the same.

Any small movements of the same must be carried out only with the machine disconnected from the power supply for ordinary cleaning operations.

- In order to prevent the risks generated by the blast chiller, all operators who come into contact with it must be equipped with adequate personal protective equipment as stated in these instructions (see chapter **“Personal protective equipment (PPE): what they are and why they should be used”** on page 8).

- The operation and use of the blast chiller must be carried out by only one qualified operator at a time; the presence of other people must be absolutely avoided as it constitutes a source of danger. It is the operator's responsibility to check that this condition is always complied with.

- All operators who use the blast chiller must know and understand the requirements contained in this manual, as well as have been previously trained.

- The knowledge of the provisions relating to use, given in this chapter, is subject to the basic knowledge of the blast chiller, which is acquired by reading the previous chapters.

- All troubleshooting operations or repairs must be carried out by specifically authorized maintenance personnel.

- ⊘ The operator in charge of the operation must in no case open or remove the protections and guards of the blast chiller. If you believe that a malfunction exists, you must have the maintenance technician intervene and operate according to the provisions of the relevant instructions.

Before turning on the appliance

Before starting to use the blast chiller, however, check that:

- the equipment is not stopped for maintenance, or cleaning;
- the equipment is connected to the power supply;
- all possible guards are correctly closed and intact;
- the control devices are fully efficient.

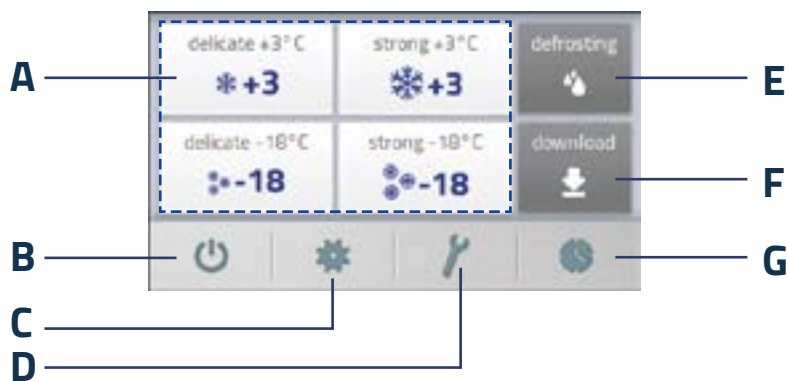

	ENGLISH
A	4 available cycles: <ul style="list-style-type: none"> +3°C 37°F DELICATE +3°C 37°F STRONG -18°C 0°F DELICATE -18°C 0°F STRONG
B	Switches the control panel ON and OFF
C	Allows access to the programming of the available cycle parameters
D	Allows access to the programming of the user parameters (e.g. date and time, language, etc.)
E	Starts a manual defrosting cycle
F	Allows downloading the HACCP data onto your own USB stick
G	Pressing it for 5 seconds displays the alarm list.

F08 Powering the equipment

Power the equipment by inserting its plug into a suitable socket or by acting on the ON/OFF switch of the electrical panel to which it is connected.



F07

F07 Turning the equipment on

Press the "ON/OFF" key; the appliance is switched on.



F08

F09 Selecting the desired cycle

Press the key relating to the cycle to be performed:

	+3°C 37°F DELICATE (cooling cycle)
	+3°C 37°F STRONG (cooling cycle)
	-18°C 0°F DELICATE (freezing cycle)
	-18°C 0°F STRONG (freezing cycle)

The temperatures preset for each cycle (+3°C | 37°F for cooling cycles and -18°C | 0°F for freezing cycles) can be modified and stored, see page 23.



F09

Pre-cooling the cell

Wait at least 5 minutes after starting the cycle (pre-cooling) before introducing the products to be blast chilled into the chamber, especially if they are very hot (>100°C | 212°F).

Choosing the working mode

The equipment has the ability to operate in the following modes:



MANUAL p. 19 ► the user must manually enter the **duration of the cooling or freezing cycle** which will end when the set time is

reached.



AUTOMATIC p. 20 ► the user must stick the core probe into the food to be blast chilled. In this way it will constantly detect the core

temperature of the food in the cell.

The cooling or freezing cycle will end when the probe detects that the temperature set for the selected cycle has been reached.

F10 MANUAL mode (timed)

1 Press the relative key to select the **timed mode** (the cycle is interrupted when the set time has elapsed). Insert the products to be treated in the cell and close the door.

2 The screen displays:

- the **temperature in the cell** (in the example 33°C | 92°F)
- the **expected cooling or freezing time** (in the example 3 hours and 30 minutes); if necessary, it is possible to modify this default time by pressing the “+” or “-” keys (keeping the key pressed for over two seconds will increase the time more quickly.)

3 Press the “**START**” key to start the cycle.

4 In the screen that appears, the cycle in progress is shown on the top left (e.g. delicate +3°C | 37°C) and on the right the percentage of completion (e.g. 90%).

5 Pressing the **i** symbol displays for 3 seconds:

- the air temperature,
- the temperature detected by the core probe
- the cycle duration.

Pressing  the screen is put into stand-by but the cycle continues.

At the end of the set time, the cycle ends and an acoustic signal is emitted.

To interrupt the cycle prematurely, press the “**STOP**” key.



F10

F11 AUTOMATIC mode (with probe)

1 Press the relative key to select the **automatic mode** (the cycle is interrupted when the core probe detects the temperature set for the chosen cycle). Insert the core probe into the products to be treated, place them in the cell and close the door.

2 The screen displays the **temperature detected by the core probe** (in the example 55°C | 131°F).

3 Press the **"START"** key to start the cycle.

4 In the screen that appears, the cycle in progress is shown on the top left (e.g. delicate +3°C | 37°C) and on the right the percentage of completion (e.g. 90%).

5 Pressing the **i** symbol displays for 3 seconds:

- the air temperature,
- the temperature detected by the core probe
- the cycle duration.

Pressing  the screen is put into stand-by but the cycle continues.

At the end of the set time, the cycle ends and an acoustic signal is emitted.

To interrupt the cycle prematurely, press the **"STOP"** key.

After cooling or freezing (maintenance phase)

At the end of a cooling or freezing cycle, the **maintenance phase** of the treated products begins, to keep them in temperature until their removal which must take place in the shortest possible time.

Do not use the blast chiller to store the already treated products but remove and store them:

- in the refrigerator at a temperature of 0/+3°C | 32/37°F where they can be kept for up to 5 days (cooling);
- in a freezer at a constant temperature of -18/-20°C | 0/-4°F (freezing). They can be consumed also after 3/18 months (depending on the type of product) as long as the cold chain is complied with.

Chilled and/or frozen food must be specially covered and protected (with film, with an airtight or better still vacuum-sealed lid) and marked with an adhesive label on which the contents, day of preparation and assigned expiry date are stated in indelible ink.

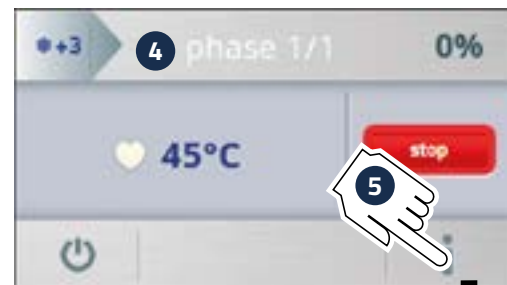

F12 Switching the equipment off

Press the "ON/OFF" key: the equipment is switched off but remains powered. To disconnect it completely, remove its plug from the socket or use the ON/OFF switch of the electrical panel to which it is connected.



F12

F13 Manual defrosting

Defrosting must take place with the door of the blast chiller open.

- 1 Press the **"DEFROSTING"** key .
- 2 The appearing screen displays the **expected defrosting time** (in the example 3 hours and 12 minutes); if necessary, it is possible to modify this default time by pressing the **"+"** or **"-"** keys (keeping the key pressed for over two seconds will increase the time more quickly.)
- 3 Press the **"START"** key to start the cycle.
- 4 In the screen that appears, the cycle in progress is shown on the top left (defrosting) and on the right the percentage of completion (e.g. 90%). To interrupt the cycle prematurely, press the **"STOP"** key.
- 5 If during the cycle the door is closed:
 - The cycle is interrupted;
 - The counter of the remaining time is blocked;
 - the indication to reopen the door is shown

Once the set time has been reached, the cycle ends.

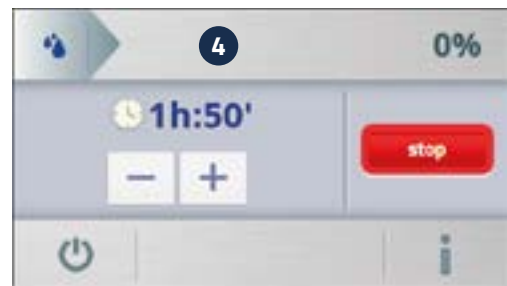





F13

F14 Data selection and download start

- 0 Insert a generic USB key into the appropriate socket as shown in the figure.
- 1 Pressing  you enter the data download page. The bar at the top shows: "Download" in the centre and download logo on the right. In the centre it shows: "Downloading..." and the downloading percentage.
- 2 At the end of the download, the display shows "Completed": if it is unsuccessful or if the USB stick is not connected, the display shows "Error". If you press the button during the download, the download will stop and you will return to the initial Home screen. The print archives remain in the memory.

RECORDING MEMORY RESET

- 3 On the data download page, with the download completed ("Completed") or with USB stick error ("Error"), press the symbol .
- 4 Press  to return to the previous screen, Pressing  you proceed with the deletion of the print log.
- 5 At the end of the deletion, the display shows the message "Deleted". With  you return to the initial Home screen.

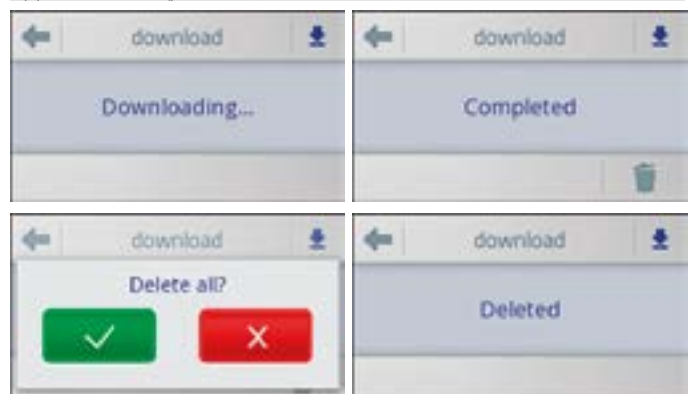
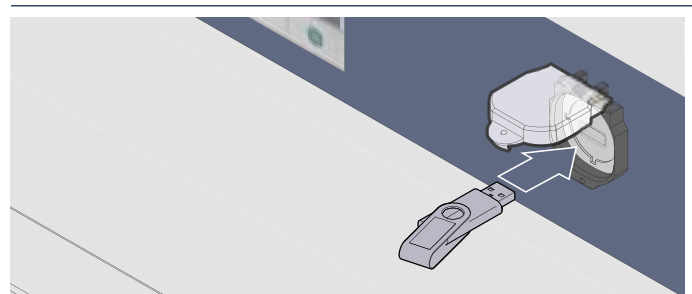

F14

F15 Parameter programming

0 You access parameter programming by pressing in the initial grid:

 to enter the cycle parameters ("PrC");

 to enter the user parameters ("PrO")

1 The password is requested.

Entering the code **9 9 9 9** and pressing **OK** you access the parameters; pressing  you return to the initial grid, pressing the **C** key you cancel the entered number.

CYCLE PARAMETERS

2 Once you enter the cycle parameters, select the cycle to modify:



 for the DELICATE cycle +3 °C | 37°F



 for the STRONG cycle +3 °C | 37°F

 for the DELICATE cycle -18 °C | 0°F

 for the STRONG cycle -18 °C | 0°F



 for the defrosting cycle.



3 Once the cycle is selected, the list of parameters that can be modified is displayed. With  and  you go on to the following/previous parameters. To save the parameter change, press **ok**. With the  key you go back to the previous parameter; if you do not press **ok** after modifying a parameter and you go back, the change is cancelled.

The  key gets you as far as the first parameter but will not get you out of the cycle parameters. Similarly,  can get you just as far as the last parameter.

USER PARAMETERS

2 Once you enter the user parameters, the list of parameters you can modify, is displayed.

With  and  you go on to the following/previous parameters. To save the parameter change, press **ok**.

With the  key you go back to the previous parameter; if you do not press **ok** after modifying a parameter and you go back, the change is cancelled. The  key gets you as far as the first parameter but will not get you out of the cycle parameters. Similarly,  can get you just as far as the last parameter.

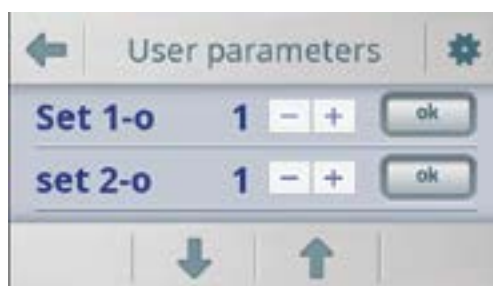

F15

Cycle parameters

+3°C 37°F DELICATE					
set No.	Description	Range	Resolution	Default	Notes
S1	PHASE_1 air set	from -40 °C -40°F to 40°C 104°F	1°C 34°F	1°C 34°F	Cooling air temp.
S3	Maintenance air set			2°C 36°F	
A1	PHASE_1 core temp. set			3°C 37°F	Cycle end core temperature
M1	PHASE_1 time		1 minute	90 minutes	Cooling duration

+3°C 37°F STRONG A= automatic cycle M = manual cycle					
set No.	Description	Range	Resolution	Default	Notes
S1	PHASE_1 air set	from -40 °C -40°F to 40°C 104°F	1°C 34°F	-20°C -4°F	First phase chill blasting air temp.
S2	PHASE_2 air set			-1°C 30°F	Cycle end chill blasting air temp.
S3	Maintenance air set			2°C 36°F	
A1	PHASE_1 core temp. set			20°C 68°F	First phase end core temp.
A2	PHASE_2 core temp. set			3°C 37°F	Cycle end core temperature
M1	PHASE_1 time	1÷ 180 min.	1 minute	30 minutes	Phase 1 cooling duration
M2	PHASE_2 time	1÷ 180 min.	1 minute	60 minutes	Phase 2 cooling duration

-18°C 0°F DELICATE					
set No.	Description	Range	Resolution	Default	Notes
S1	PHASE_1 air set	from -40 °C -40°F to 40°C 104°F	1°C 34°F	0°C 32°F	First phase freezing air temp.
S2	PHASE_2 air set			-35°C -31°F	Cycle end freezing air temp.
S3	Maintenance air set			-19°C -2°F	
A1	PHASE_1 core temp. set			6°C 43°F	First phase end core temp.
A2	PHASE_2 core temp. set			-18°C 0°F	Cycle end core temperature
M1	PHASE_1 time	1÷ 480 min.	1 minute	60 minutes	Phase 1 freezing duration
M2	PHASE_2 time	1÷ 480 min.	1 minute	180 minutes	Phase 2 freezing duration

-18°C 0°F STRONG					
set No.	Description	Range	Resolution	Default	Notes
S1	PHASE_1 air set	from -40 °C -40°F to 40°C 104°F	1°C 34°F	-35°C -31°F	Freezing air temp.
S3	Maintenance air set			-19°C -2°F	
A1	PHASE_1 core temp. set			-18°C 0°F	First phase end core temp.
M1	PHASE_1 time	1÷ 480 min.	1 minute	240 minutes	Freezing duration

DEFROSTING					
set No.	Description	Range	Resolution	Default	Notes
1	Defrost cycle time	1÷ 120 min.	1 minute	30 minutes	Freezing air temp.

User parameters

set No.	Range	Default values	Description
Hour	from 0 to 23	0	Setting the hour
Min	from 0 to 59	0	Setting the minutes
Year	from 15 to 99	15	Setting the year
Month	from 1 to 12	1	Setting the month
Day	from 0 to 31	1	Setting the day in the month
DST	0= YES 1= NO	0	Setting the summer time
Scale	0= °C 1= °F	0 (°C)	Setting the temperature unit of measurement
Freq	from 1 to 15 min.	15 minutes	Setting the recording frequency expressed in minutes
Mode	0= only cooling 1= freezing+maintenance	0	Recording mode selection
Id	from 1 to 99	1	Setting the machine number
Lang	1= English	1	Selecting the printing language
Rev			Software release display - 3 digits
Beep	0= ON 1= OFF	1	Key sound enabling
14-o	0= sanitizing disabled 1= sanitizing enabled	0	Sanitation measures
15-o	from 0°C 32°F to 15°C 59°F	0°C 32°F	Sanitizing start temperature
16-o	from 0 to 6 hours	40 minutes	Sanitizer ON time
17-o	from 0 to 24 hours	6 hours	Sanitizer OFF time
18-o	from 1 to 60 seconds	10 seconds	Evaporator fans ON time (RL2)
19-o	from 1 to 60 minutes	10 minutes	Evaporator fans OFF time (RL2)
20-o	from 0 to 10	3	Sanitizer inhibition cycle count

Maintenance



Safety warnings

● Before carrying out any routine maintenance, it is necessary to disconnect the power supply of the equipment. The operator must be at all times in a position to verify that no connection is restored.

● The operator in charge of cleaning must be provided with adequate personal protective equipment (see chapter **“Personal protective equipment (PPE): what they are and why they should be used”** on page 8).

● Extraordinary maintenance operations (e.g. replacement of faulty components) are reserved for specialized maintenance personnel. The operator must limit himself to the normal routine cleaning of the surfaces, complying with the following warnings and the methods indicated in the specific chapter. For extraordinary maintenance, contact a Service Centre requesting the intervention of an authorized technician.

● A sign must be placed near the cable with the blast chiller power supply, indicating that disconnection has taken place as a maintenance or cleaning operation is in progress, and the power supply must not be restored.

The warranty lapses in the event of damage caused by poor or incorrect maintenance (e.g. use of unsuitable detergents).

⊘ To clean any component or accessory DO NOT use:

- abrasive or powder detergents;
- aggressive, flammable, corrosive detergents or solvents (e.g. hydrochloric/muriatic or sulphuric acid, caustic soda, etc.). Warning! Do not use these substances even to clean the floor under the appliance;
- abrasive or pointed tools (e.g. abrasive sponges, scrapers, steel brushes, etc.);
- jets of steam or pressurized water.

On first use, wash the chamber using a cloth soaked in a neutral-based detergent and finish with rinsing and drying with the door open with a manual defrost cycle (remember to remove the plug on the bottom of the cell).

To eliminate the processing residues, operate the equipment empty for about 30 minutes.

● The substances used for cleaning and disinfecting the surfaces of the blast chiller must be compatible with the materials of the blast chiller and with hygiene requirements.

⊘ Do not remove the blast chiller protections to perform maintenance and cleaning operations.

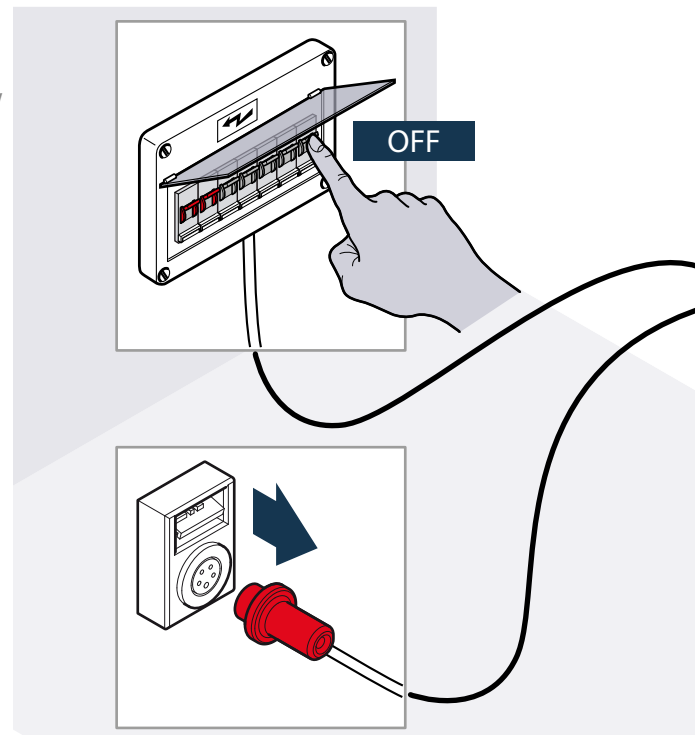

- Make sure you have completely dried the blast chiller before use.
- When disposing of the blast chiller, it is necessary to destroy its identification plate, as well as the documentation provided for purchase.

Ordinary cleaning

Cleaning the control panel

- F16** Use a cloth lightly soaked in a neutral-based product (non-alcoholic) following the instructions of the detergent manufacturer.
- Do not spray too much product to avoid infiltrations that might damage the display.

Cleaning of steel surfaces and the inside of the refrigerated compartment

Use a cloth soaked in a neutral-based detergent or specific products for steel. Finish with rinsing and drying with the door open with a manual defrost cycle. Remove the plug on the bottom of the cell. Cleaning of the refrigerated compartments must be done daily to maintain high levels of hygiene and the performance of the equipment. Check that the water contained in the condensate collection tray under the condenser does not stagnate for a long time. If yes, contact the Manufacturer to find solutions.

Cleaning the slots in the compressor unit compartment

- F17** We also recommend you vacuum the dust accumulated on the slots of the condenser grille approximately every 30 days. This practice is very important to maintain high levels of hygiene and the performance of the equipment.

Cleaning the core probe

Before cleaning the core probe, always wait for it to cool down. Use a cloth soaked in warm soapy water or specific products for steel. Finish with a rinse and dry.

- ⚠** Handle the probe carefully as it is very sharp and reaches high temperatures after use.

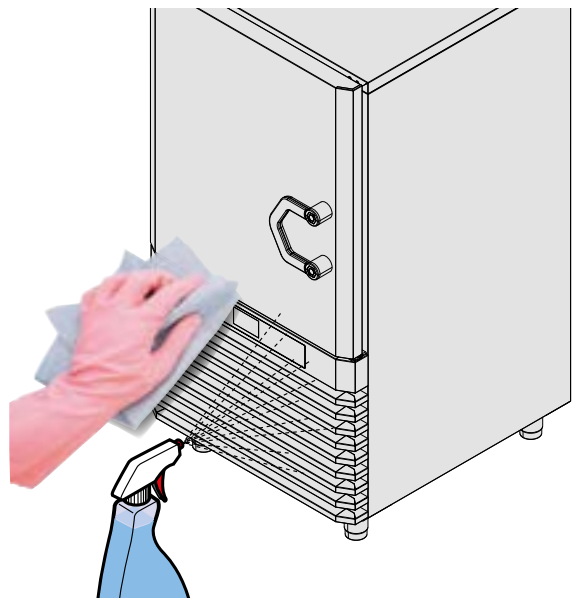

F16

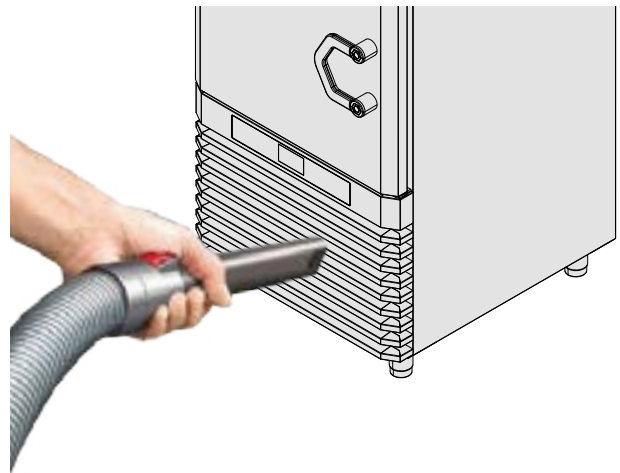

F17

Defrosting

At the end of the day and between one cycle and another, it is always recommended to start a defrost cycle, see p. 27.

Emptying the condensate tray

F18 The blast chiller is equipped with a special tray to collect condensation and washing water, located in the lower part of the cabinet. Periodically empty and clean the bowl, pulling it out from under the cabinet.

Cleaning and replacing the filter

F19 The filter must be cleaned every 20 hours or weekly, also based on the working conditions of the machine (if the environment is very dusty, such as with flour or similar, cleaning will be more frequent). To access the filter it is necessary to open the door and pull the front grille towards you with a slight force. Clean the filter by blowing it with compressed air, alternatively wash it with hot water and a neutral detergent or replace it. After cleaning, when closing the grille, make sure that the plastic pins lock into the appropriate spaces. Do not operate the machine without a filter or with a filter that is not perfectly dry.

Cleaning the seal

Periodically check the condition and tightness of the door seal; if it is damaged, contact an authorized dealer or service centre for replacement.

Clean it with a cloth soaked in warm soapy water.

Finish with rinsing and drying with the door open with a manual defrost cycle.

Weekly cleaning

At the same time also clean the plastic of the seal to ensure perfect adherence.

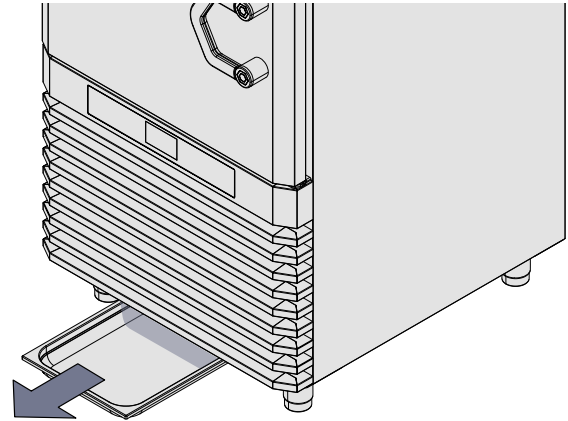

F18

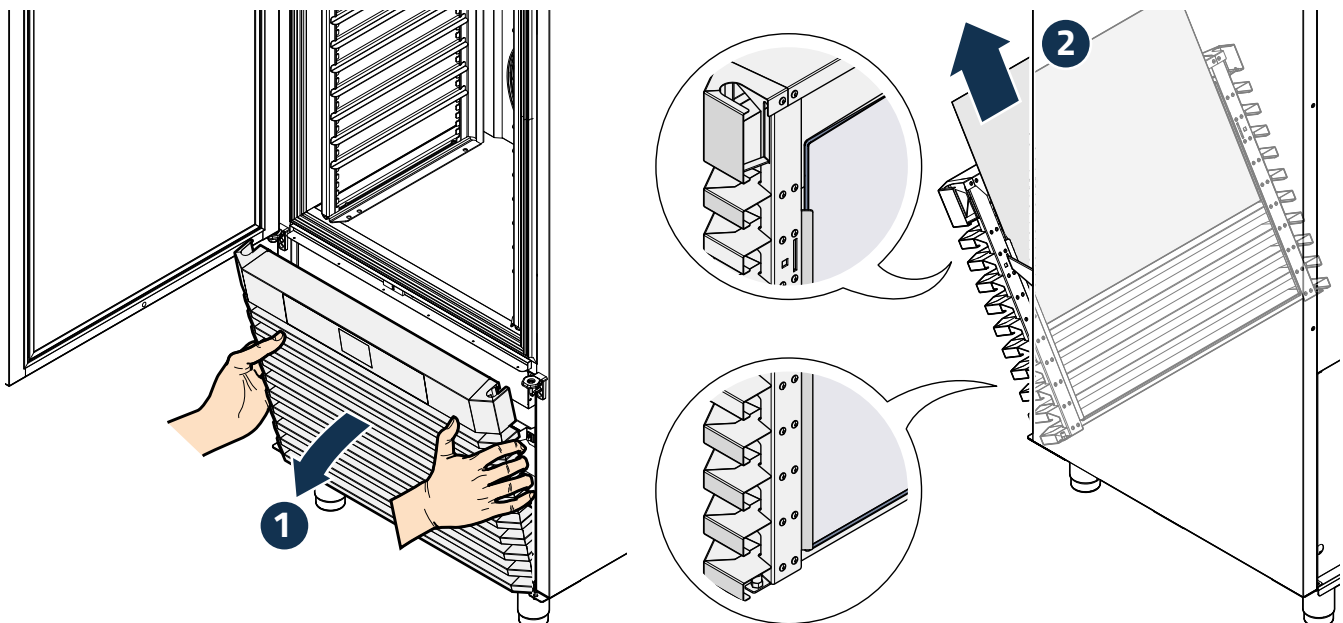

F19

Maintenance table

Maintenance activity	Daily	Weekly	Monthly	Every six monthly	Annually	Biennially	Electrical identifying code	Notes
ORDINARY CLEANING OPERATIONS								
Defrosting with the door open	C							
Core probe cleaning	C						RV2	
Door seal cleaning		C						
Chamber cleaning (with neutral detergent)			C					
Condenser filter cleaning		C						
Multi Rack cleaning			C					
CHECKS								
Door alignment and closure checks					T			
Evaporator surface check					T			
Condenser surface check					T			
Electrical panel check (connection check and cleaning)					T			
Core probe reading check					T		RV2	
Air probe reading check					T		RV1	
Sanigen® absorption check (0.003A)					T		SN1	
Door element absorption check					T		R1	
Evaporator fan absorption check					T		M3/4/5	
Condenser fan absorption check					T		M2	
Compressor absorption check					T		M1	
Gas leak check					T			
FUNCTIONAL TESTS								
Pull down test					T			
REPLACEMENT OF COMPONENTS SUBJECT TO WEAR								
Door seal replacement					T			
Replace compressor remote control switch						T	KM1	
Starting capacitor replacement					T		C1/2/3/4	
Frame cover replacement						T		
Sanigen® capsule replacement					T			
Condensation drain tube replacement						T		
Condenser air filter replacement					T			

C: customer
T: technician

Downtime

During periods of inactivity, disconnect the power supply. Protect the external steel parts of the equipment by wiping them with a soft cloth soaked in Vaseline oil. Leave the door ajar in order to ensure proper air exchange.

Upon recovery, before use:

- thoroughly clean the equipment and accessories;
- reconnect the equipment to the power supply;
- check the equipment;
- restart the appliance for at least 60 minutes without any food inside.

End of life disposal

Disconnection from the electrical and hydraulic circuits must only be carried out by qualified technicians. If present, recover and correctly dispose of:

refrigerant gas;

non-freezing solutions present in hydraulic circuits, preventing spills or leaks into the environment.

Pursuant to art. 13 of Legislative Decree No. 49 of 2014 "Implementation of the WEEE Directive 2012/19/EU on electrical and electronic waste"

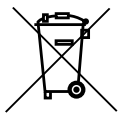

IT08020000000615

The barred bin specifies that the product was placed on the market after 13 August 2015 and that at the end of its useful life it must not be treated as other waste but must be disposed of separately.

All the appliances are made of recyclable metal materials (stainless steel, iron, aluminium, galvanized sheet, copper, etc.) in a percentage greater than 90% by weight. Make the equipment unusable for disposal by removing the power cable and any compartment or cavity closing device (where present). It is necessary to pay attention to the management of this product at its end of life by reducing negative impacts on the environment and improving the efficiency of use of resources, applying the principles of "polluter pays", prevention, preparation for reuse, recycling and recovery. Please note that the abusive or incorrect disposal of the product entails the application of the penalties provided for by the current legislation.

Information on disposal in Italy

In Italy WEEE equipment must be delivered: to Collection Centres (also called ecological islands or ecological platforms) to the dealer where you buy new equipment, which is required to collect it free of charge ("one on one" collection).

Information on disposal in European Union countries

The EU WEEE equipment directive has been transposed differently by each country, therefore if you want to dispose of this equipment we suggest you contact the local authorities or the dealer to ask for the correct method of disposal.

Building materials

Stainless steel: construction of the case;

Plastic parts;

Refrigerant gas: in the refrigeration circuit;

Compressor oil: in the cooling circuit;

Copper: electrical system and cooling circuit.

After-sales service

Your equipment is reliable and robust but sometimes small problems can arise which, thanks to our Service Centres, will be promptly resolved.

Before contacting them, carefully read the warranty sheet attached to the equipment and note the data of the same (serial number plate) and the date and number of the equipment purchase invoice;

Serial number (S/N)
 Model.....
 Transport document date
 Transport document number.....

If it is necessary to replace the faulty parts, keep them and entrust them to the installer in charge of replacement so that they are sent to the Manufacturer for the necessary checks.

⊘ Do not attempt to repair the equipment yourself, this could cause serious damage to people, animals and property and voids the Warranty. Always request the intervention of an Authorized Service Centre and request ORIGINAL spare parts.

Manufacturer: Irinox SpA Headquarter: Via Caduti nei Lager, 1
 31015 Conegliano (TV) Italy
 Operational headquarters: Viale Mattei, 20
 31029 Vittorio Veneto (TV) Italy
 Service: service@irinox.com
 Tel. +39 0438 5844

Machine: EasyFresh Next chiller

Model

Serial number

(year/month/progressive)

Volt

Absorption

Climate class

IRINOX		Viale Enrico Mattei, 20 31029 - Vittorio Veneto (TV) Italy	
Mod. EF NEXT L			
s/n 200300086M			
400-415 V		3N	ph 50 Hz
6,5	A	3,9	kW
Compressor HERMETIC			
Gas R452A		Charge 2120 g	
Design Lp 18(-40/100°C) BAR		Design Hp 30(-10/100°C) BAR	
PSV 30		Heater -- --	
Class 4		Volume 332 dm ³	
Rated Load 50 Kg			
IP x4 Ins. blow. gas. CO2			
PED code 948			
MADE IN ITALY			

Machine size

Phase

Mains frequency

Power

Climate class: **4** (ambient temperature 32°C with 55% non-condensing relative humidity) according to IEC EN 60335-1, IEC EN 60335-2-89

F20

USA - CANADA models

Model

Machine size

Serial number

(year/month/progressive)

Volt

Power

Climate class

IRINOX		Viale Enrico Mattei, 20 31029 - Vittorio Veneto (TV) Italy	
Mod. EF NEXT LL		Phase	
s/n. 200200298M		Mains frequency	
208	V 3	Ph 60	Hz TOTAL AMPS 10 A
Design HP 390	PSIG	MOPD 20	A MCA 15 A
Design LP 275	PSIG	Gas R404A	Charge 74 oz
Compressor	RLA 8,3	A	LRA 48,5 A
Condenser Fan Motor	n° fan 1	1,5	A
Evaporator Fan Motor	n° fan 3	FLA 0,5	A
Heating power --	--	Yield 50	kg
Cond. Mode AIR		Ins. blow. gas. CO2	
Climatic class 4			
USE COPPER CONDUCTORS ONLY UTILISER DES CONDUCTEURS EN CUIVRE SEULEMENT			

Climate class: **4** (ambient temperature 32°C with 55% non-condensing relative humidity) according to IEC EN 60335-1, IEC EN 60335-2-89

Troubleshooting

The electronic control of the machines is equipped with a visual system that signals the presence of an alarm. Alarms are recorded in an alarm list.













Diagnostics managed by electronics:

- The  symbol lights up
- The alarm code is displayed

ALARM LIST

ALARM CODE	Description	Likely cause	Likely solution
ALD	Open door alarm (with closed door)	Faulty magnetic contact	Technician's intervention
AS1	Faulty S1 cell probe	Faulty S1 probe	S1 probe replacement
AS2	Faulty S2 cell probe	Faulty S2 probe	S2 probe replacement
AS3	Total block with S1 and S2 probes faulty	S1 and S2 probes faulty	S1 and S2 probe replacement

ALARM DISPLAY

PHASE	Description	Front panel screen
0	Initial condition	
1	Press  for 5 seconds. The alarm list will be displayed. Up to 5 alarms are saved and with the  and  keys you can scroll through the alarm list starting from the most recent. If no alarms have been recorded, "NO ALARM" is displayed. With the  key you go back to the initial grid.	
ALARM RECORDING MEMORY RESET:		
2	Press  to delete the alarm list.	
3	A screenshot is displayed requesting deletion: Pressing  you return to the previous screen; Pressing  you proceed with the deletion of the alarm log.	
4	Once you confirm the deletion, the display will show "ALARM RESET" for 3 seconds and then revert to the initial grid.	

Fault table

For any malfunction found among those listed below, contact the authorized dealer or the service centre who will be able to assist you in solving your problem. Furthermore, the indications given have been summarized and other causes and relative solutions are available on specific documentation provided to authorized dealers or service centres.

Malfunction	Causes	Solutions
The display panel does not turn on	No power supply from the general socket	Check that the power cable is correctly connected to the electrical socket and that there is actually voltage across the phase conductors. The power supply must comply with the information on the appliance data plate.
All evaporator fans - in the chamber - failed.	All fans have failed	Contact an authorized dealer or service centre
	The fans are mechanically blocked	Make sure that no ice has formed on the evaporator such as to prevent the fans from operating. Make sure there is no packing material restricting or blocking the operation of the fans.
	The fans failed at different times	At the end of the day we always recommend you start a defrost cycle, as per the operator manual. During defrosting you can check if all the fans are working.
All the condenser fans are faulty	All fans have failed	Contact an authorized dealer or service centre
No evaporator defrosting	Door not completely open during the cycle.	Make sure the door of the appliance is fully open. This allows hot air to enter the evaporator through the operation of the evaporator fans.
	Wrong programming of the defrost cycle (insufficient time).	Check the cycle programming and use 30 minutes as standard time.
	All evaporator fans are faulty.	See in this table *All evaporator fans - in the chamber - failed.
	Very low room temperature (below 16°C).	Make sure that the temperature of the room where the appliance is installed is above 16°C for its proper operation.
	defrost cycle not started.	Make sure that, once selected, the defrost cycle has started.

The compressor is running but the temperature in the chamber does not drop	Evaporator packed with ice.	Start a defrost cycle lasting at least 30 minutes and remove the condensate drain plug from the bottom of the chamber. WARNING: Always perform at least one defrost at the end of the working day. If necessary, depending on the type of process, perform a quick defrost between one cycle and the next.
	All evaporator fans are faulty.	See in this table *All evaporator fans - in the chamber - failed.
	Incorrect chamber probe reading.	Contact an authorized dealer or service centre.
The compressor works but the temperature in the chamber drops slowly	Evaporator packed with ice.	Start a defrost cycle lasting at least 30 minutes and remove the condensate drain plug from the bottom of the chamber. WARNING: Always perform at least one defrost at the end of the working day. If necessary, depending on the type of process, perform a quick defrosting between one cycle and the next.
	Dirty condenser filter.	Clean the filter as shown in the User manual.
	System empty of gas.	Contact an authorized dealer or service centre.
	One or more evaporator fans are not working (depending on the model).	Contact an authorized dealer or service centre.
Presence of frost on the product and on the cell during a freezing function.	Door seal does not guarantee tightness to the body.	Check the tightness of the door seal on the frame covers. Insert a sheet of paper between the seal and the frame covers and, once the door is closed, check all around the perimeter of the chamber that the sheet of paper is not free to move. Where the sheet moves easily, there will be puffs of frost towards the inside of the chamber (happening when the drain plug on the bottom is not used). If, on the other hand, the frost is present evenly over the entire chamber, it means that the seal is not tight (the sheet of paper moves freely around almost the entire perimeter) and it is necessary to either align the door, or replace the door seal with a new one (recommended once a year). Contact an authorized dealer or service centre. The uniform presence of frost on the product and chamber is also a symptom of excessive door opening during negative cooling cycles.

Presence of frost on the product and on the cell during a freezing function.	High number of hourly door openings.	Reduce door openings. The frost that settles on the product and on the surfaces of the chamber is hot and humid air. Moisture, in contact with cold surfaces, condenses until it freezes. Frequent door openings help to introduce hot and humid air into the chamber and consequently onto the product.
	The drain plug on the bottom of the chamber is missing.	Insert the drain plug, essential to avoid puffs of ice inside the chamber.
	Extremely hot and humid environment	Reduce door openings. The frost that settles on the product and on the surfaces of the chamber is hot and humid air. Moisture, in contact with cold surfaces, condenses until it freezes. Frequent door openings help to introduce hot and humid air into the chamber and consequently onto the product.
	Misaligned door	Contact an authorized dealer or service centre.
Abnormal compressor noise in the very first instants of start-up.	Prolonged machine downtime.	The noise disappears after a few seconds of operation. It does not affect the compressor performance and reliability over time.
Condensation on the frame covers	Misaligned door.	Contact an authorized dealer or service centre.
	Door seal does not guarantee tightness to the body.	Check the tightness of the door seal on the frame covers. Insert a sheet of paper between the seal and the frame covers and, once the door is closed, check all around the perimeter of the chamber that the sheet of paper is not free to move. Where the sheet moves easily, there will be puffs of frost towards the inside of the chamber (happening when the drain plug on the bottom is not used). If, on the other hand, the frost is present evenly over the entire chamber, it means that the seal is not tight (the sheet of paper moves freely around almost the entire perimeter) and it is necessary to either align the door, acting on the lower hinge, or replace the door seal with a new one (recommended once a year). The uniform presence of frost on the product and chamber is also a symptom of excessive door opening during negative cooling cycles.

Any unauthorized reproduction, even partial, of the contents of these instructions is expressly prohibited. These instructions, as well as all the accompanying documentation, were checked before the sale. If errors or inaccuracies are found, please inform the manufacturer of the blast chiller. The manufacturer reserves the right to make improvements to the equipment or accessories at any time, without prior notice. The supplied measurements are indicative and not binding. In case of controversy, the original drafting language of the manual is Italian. The Manufacturer is not responsible for any translation/interpretation errors.

IRINOX

The Freshness Company®

Irinox SpA

Headquarter
Via Caduti nei Lager, 1
31015 Conegliano (TV) Italy

Sede Operativa
Viale Mattei, 20
31029 Vittorio Veneto (TV) Italy
T. +39 0438 2020

irinox@irinox.com
irinoxprofessional.com

[in](#) [@](#) [f](#) [▶](#)